

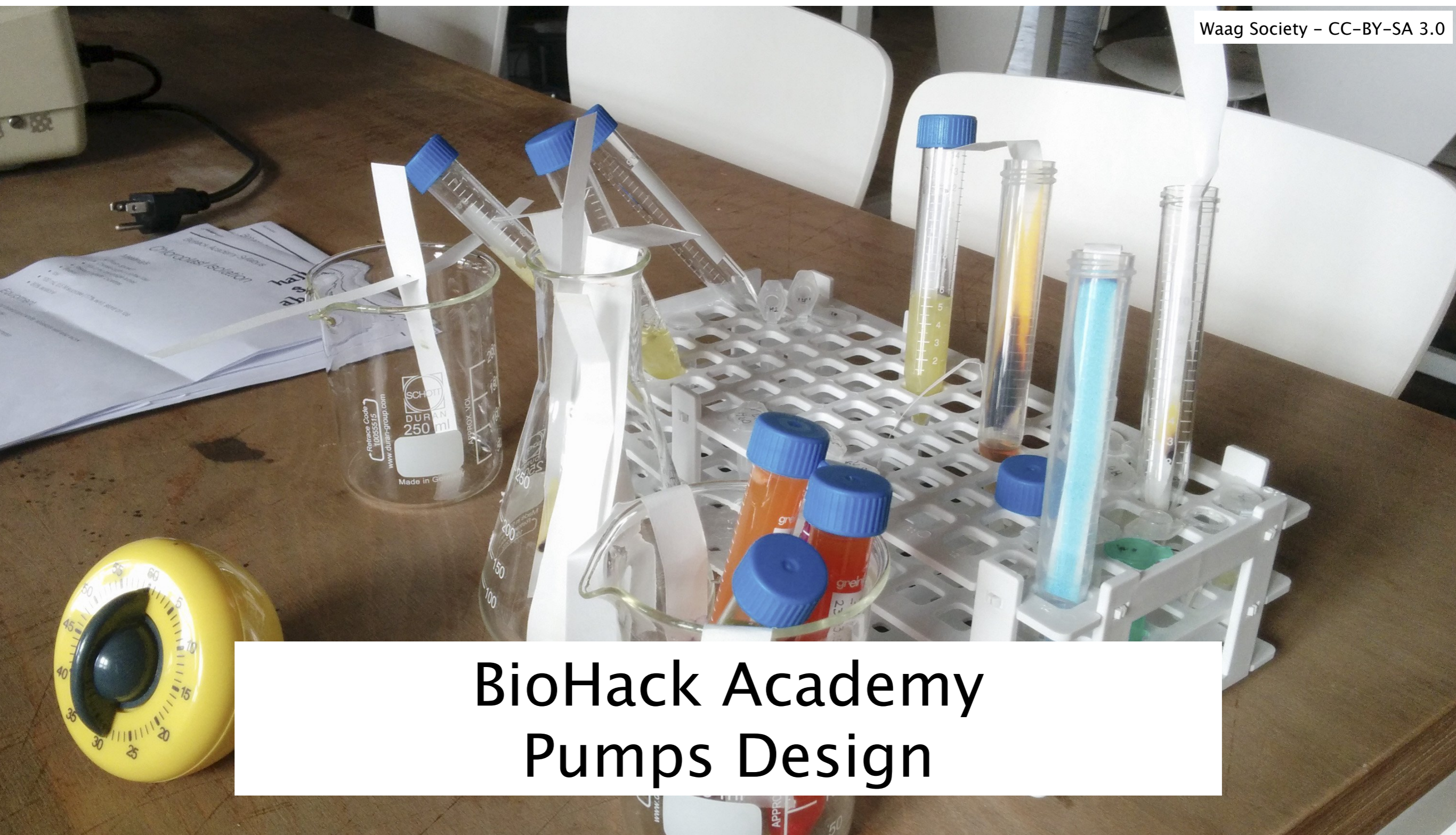

waag society

institute for art, science and technology

Waag Society - CC-BY-SA 3.0



BioHack Academy Pumps Design



Content

- Syringe pump
- Peristaltic pump



waag society

institute for art, science and technology

Syringe Pump



BioHack Academy design

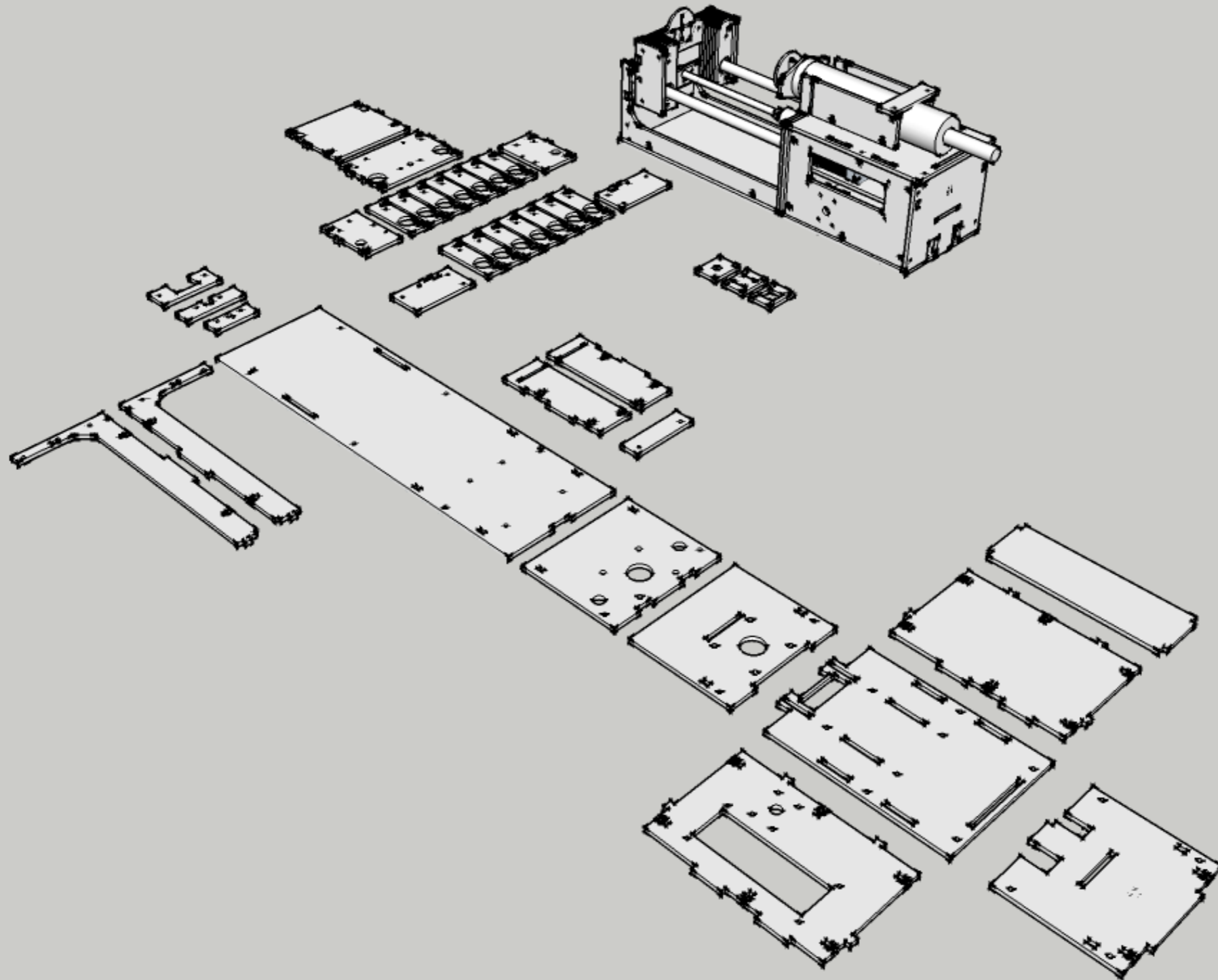



BioHack Academy design

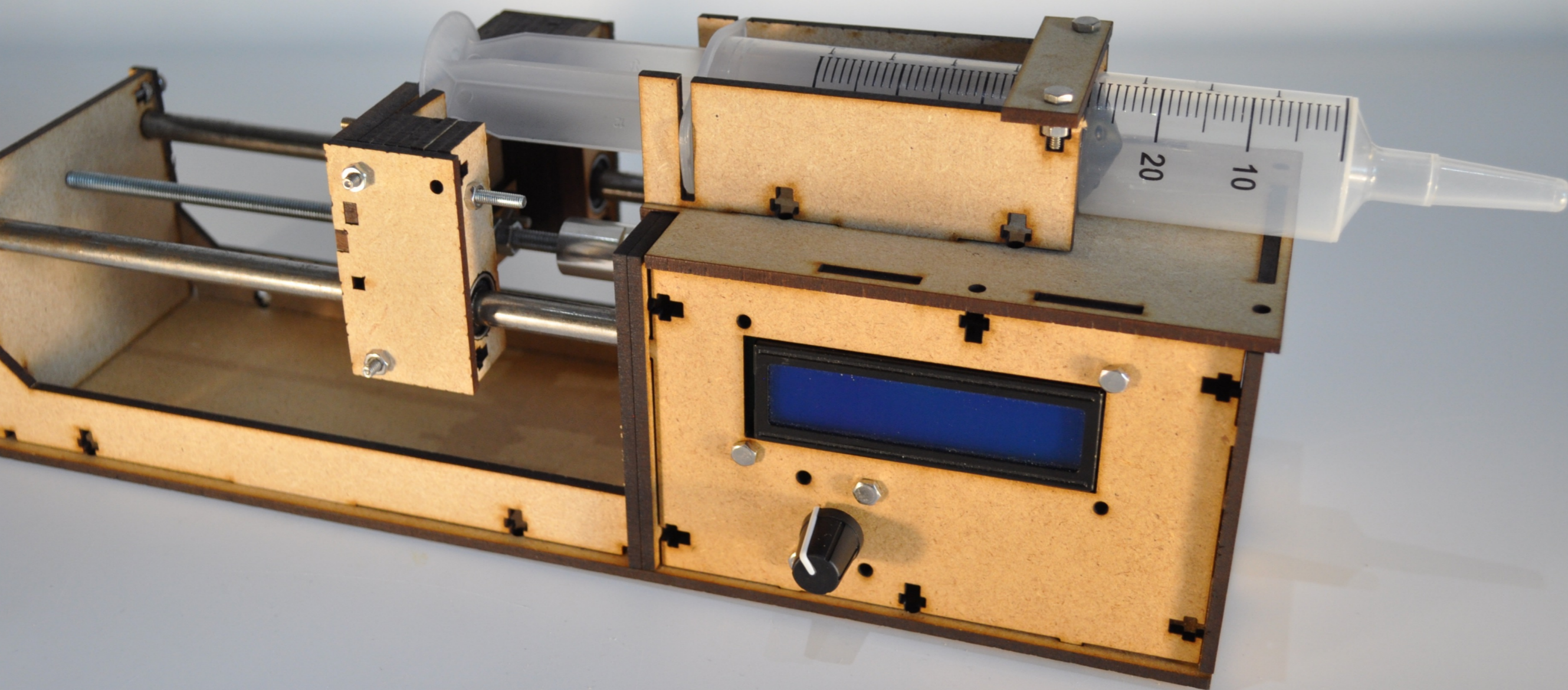



BioHack Academy design

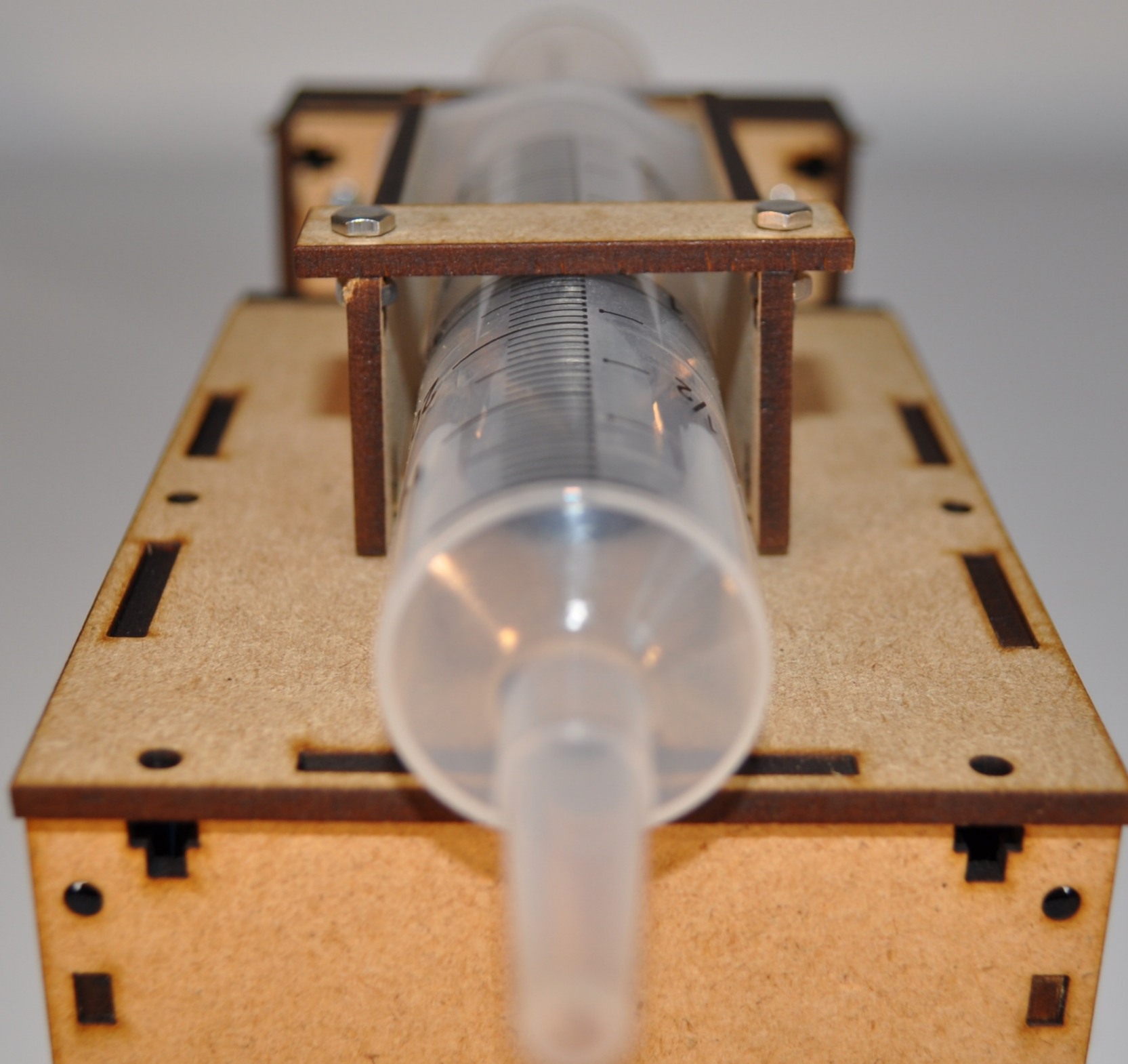



Bill of Materials

No	Amount	Description	Supplier NL	Cost
1	1	NEMA17 Stepper motor	RepRapWorld	12.50
2	1	Pololu Stepper Driver	RepRapWorld	11.99
3	1	8mm smooth rod	RepRapWorld	2.99
4	2	LM8UU Linear Bearings	RepRapWorld	1.99
5	1	Axis coupling	RepRapWorld	1.99
6	1	M5 threaded rod	RepRapWorld	2.15
7	3	Hexagonal M5 nut	RepRapWorld	0.09
8	1	100 uF capacitor	RepRapWorld , Farnell	0.20
9	1	Rotary encoder	Farnell , iPrototype , EEO	0.42
10	1	Knob	Farnell	0.23
11	2	10K resistor	Farnell , EEO	0.03
12	2	10nF capacitor	Farnell , iPrototype , EEO	0.14
13	2	100nF capacitor	Farnell , EEO	0.14
14	1	12V 5A Power supply	Farnell , EEO	38.13
15	4	Rubber feet	Conrad	0.08
16	1	I2C LCD display	iPrototype , Hackerstore	8.95
17	1	Breadboard	Farnell , iPrototype	2.56



Electronics

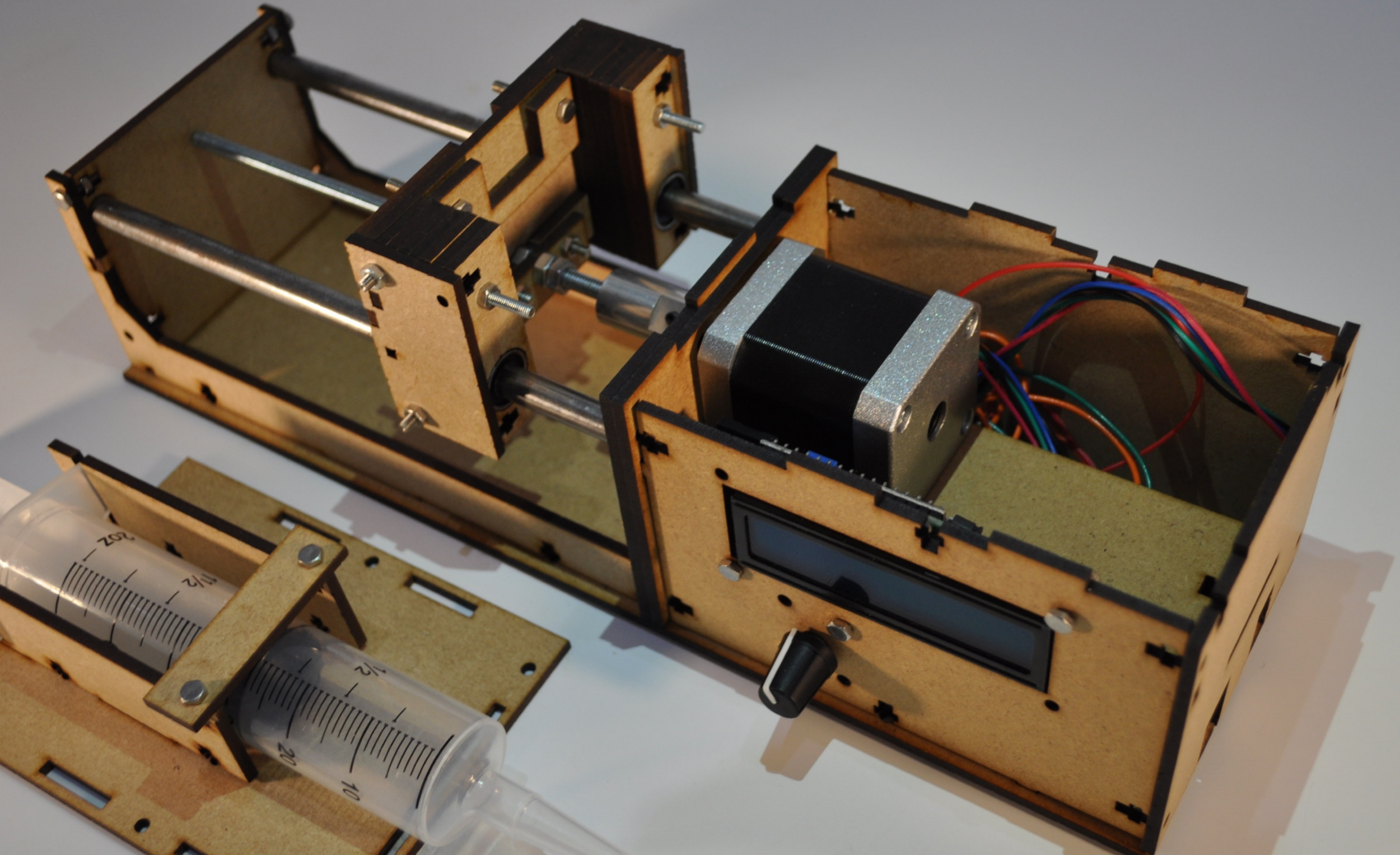



Electronics

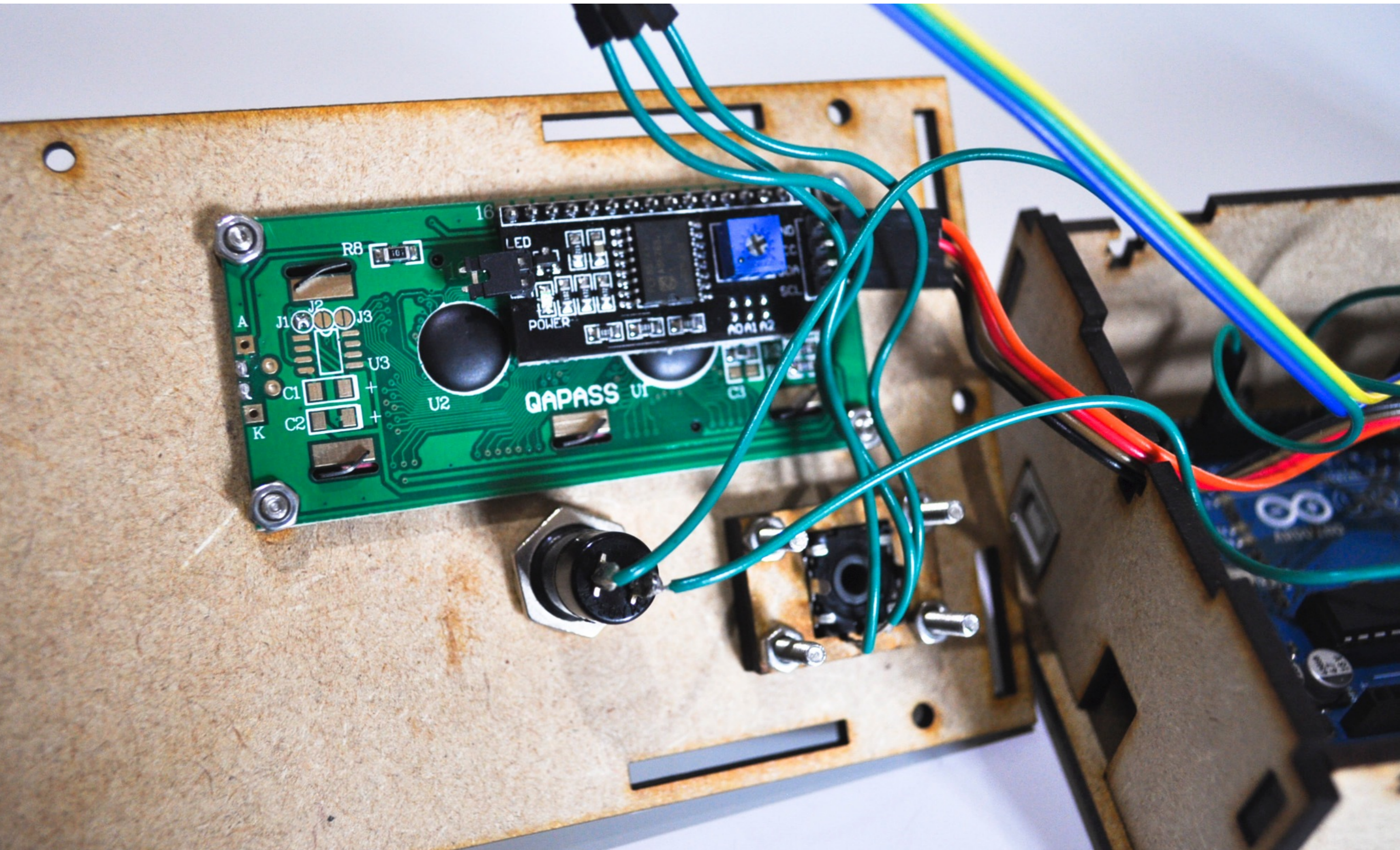



Component Wiring

Peristaltic Pump connection diagram

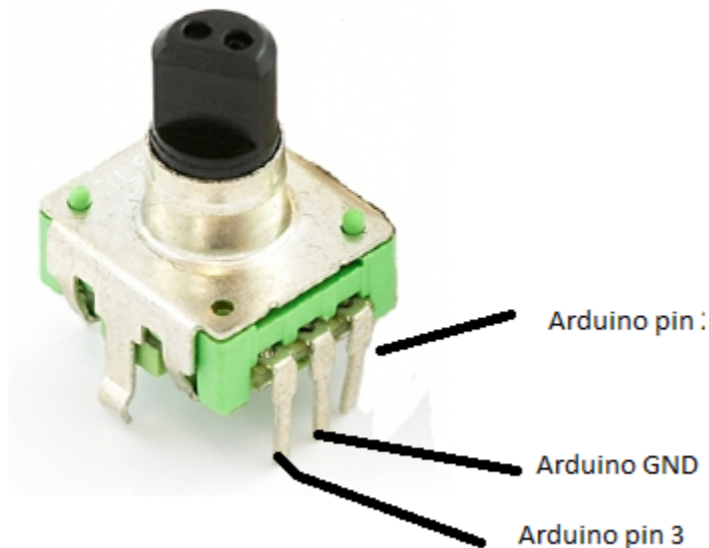
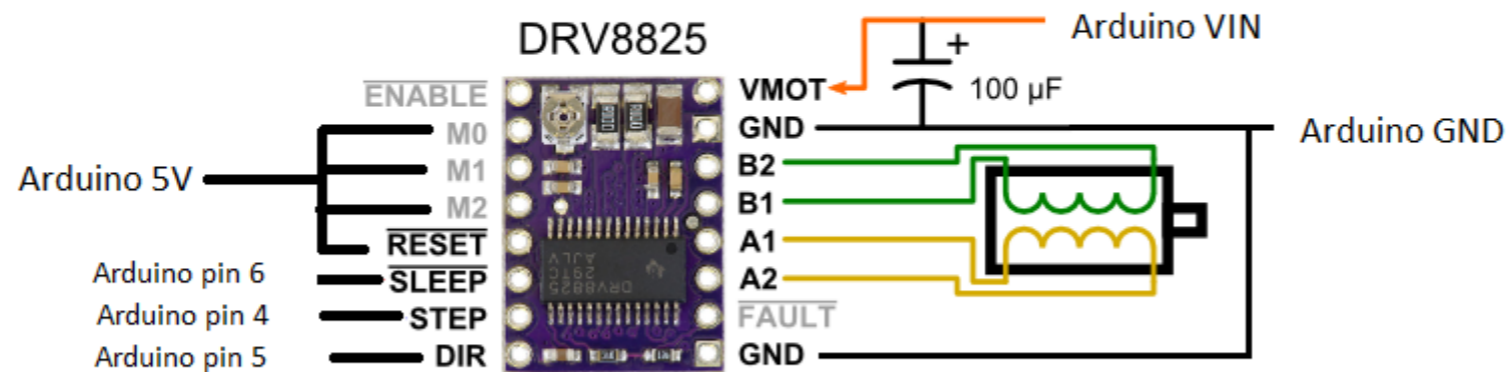



waag society

institute for art, science and technology

Peristaltic pump



BioHack Academy design

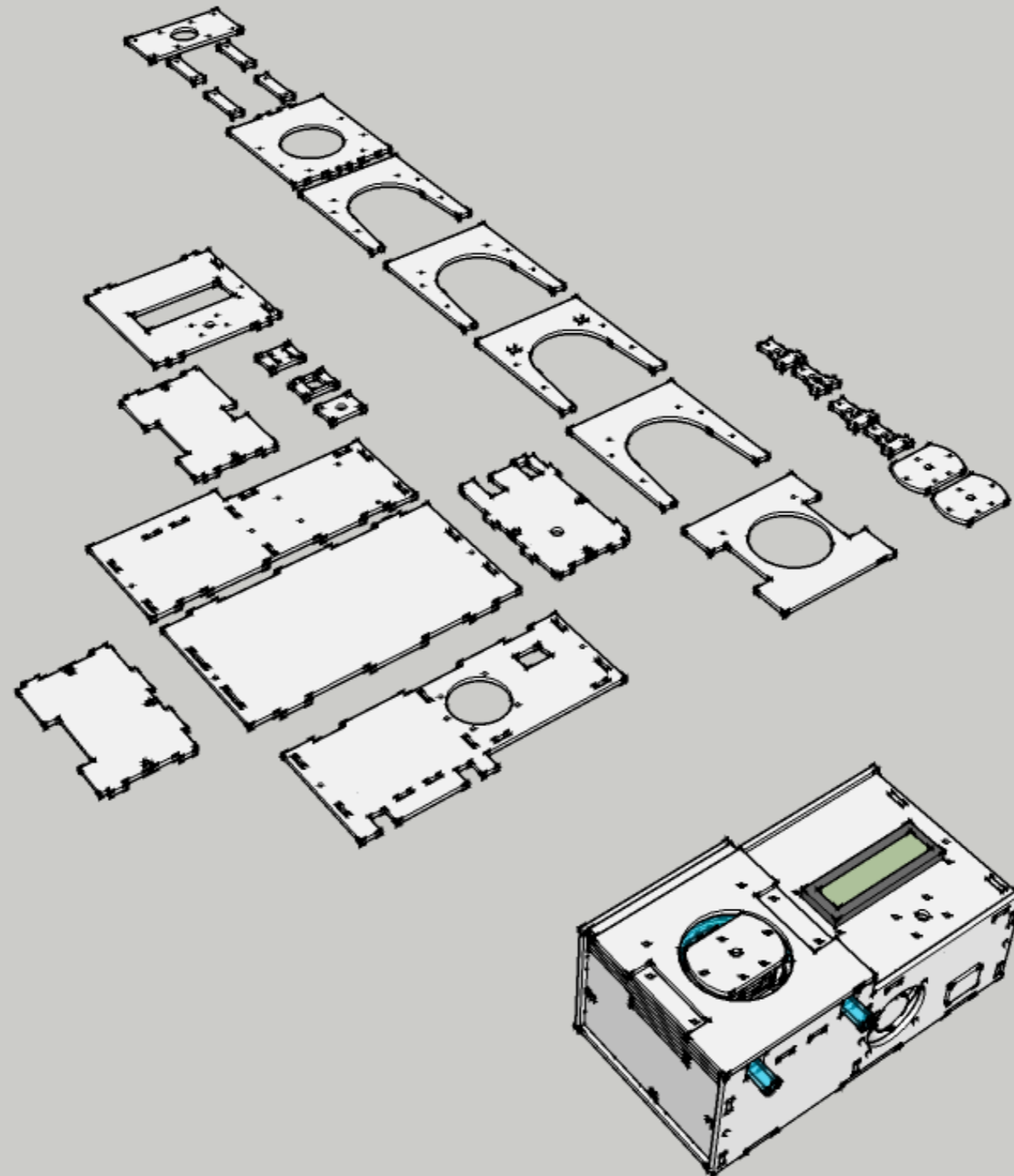



BioHack Academy design

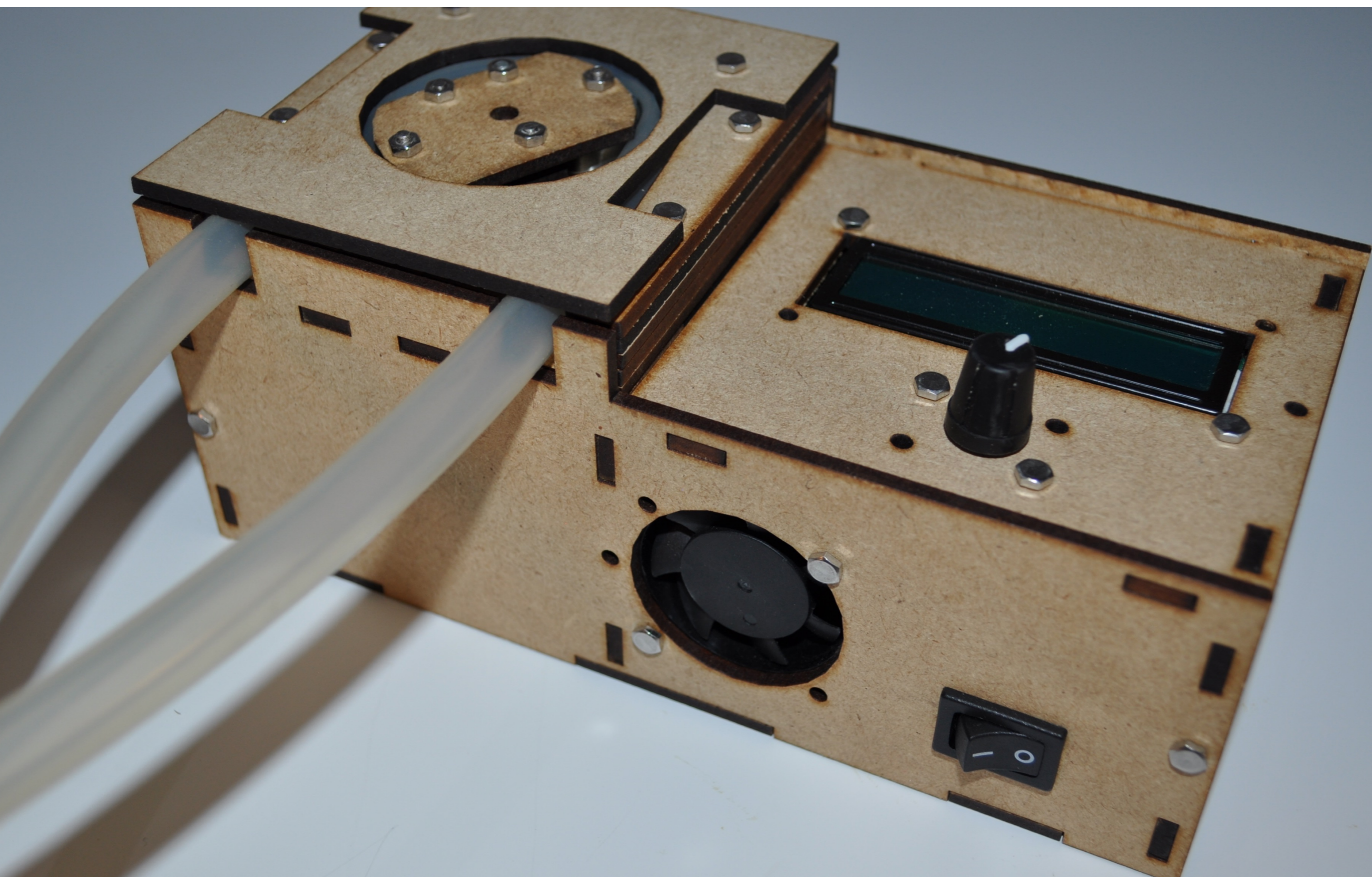



BioHack Academy design

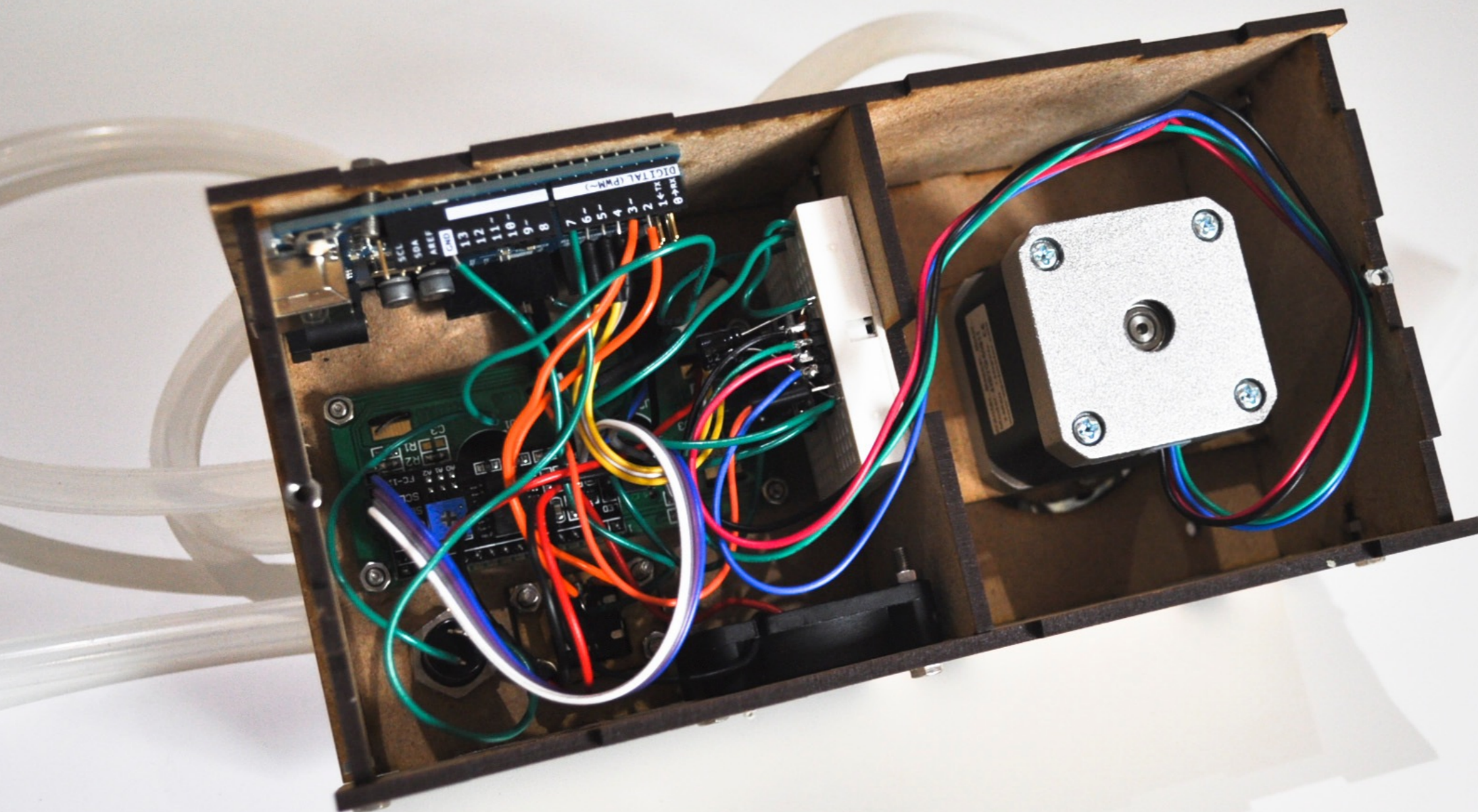



Bill of Materials

No	Amount	Description	Supplier NL	Cost
1	1	NEMA17 Stepper motor	RepRapWorld	12.50
2	1	Pololu DRV8825 Stepper Driver	RepRapWorld	11.99
3	2	Bearing 608ZZ	RepRapWorld	0.25
4	1	100 uF capacitor	RepRapWorld , Farnell	0.20
5	1	Heatsink	RepRapWorld	1.25
6	1	10 pack washers	RepRapWorld	1.99
6	1	Fan 40x40mm	EEO	1.55
7	1	Rotary encoder	Farnell , iPrototype , EEO	0.42
8	1	Knob	Farnell	0.23
9	2	10K resistor	Farnell , EEO	0.03
10	2	10nF capacitor	Farnell , iPrototype , EEO	0.14
11	2	100nF capacitor	Farnell , EEO	0.14
12	1	12V 5A Power supply	Farnell , EEO	38.13
13	4	Rubber feet	Conrad	0.08
14	1	I2C LCD display	iPrototype , Hackerstore	8.95
15	1	Breadboard	Farnell , iPrototype	2.56



Axismounted bearings



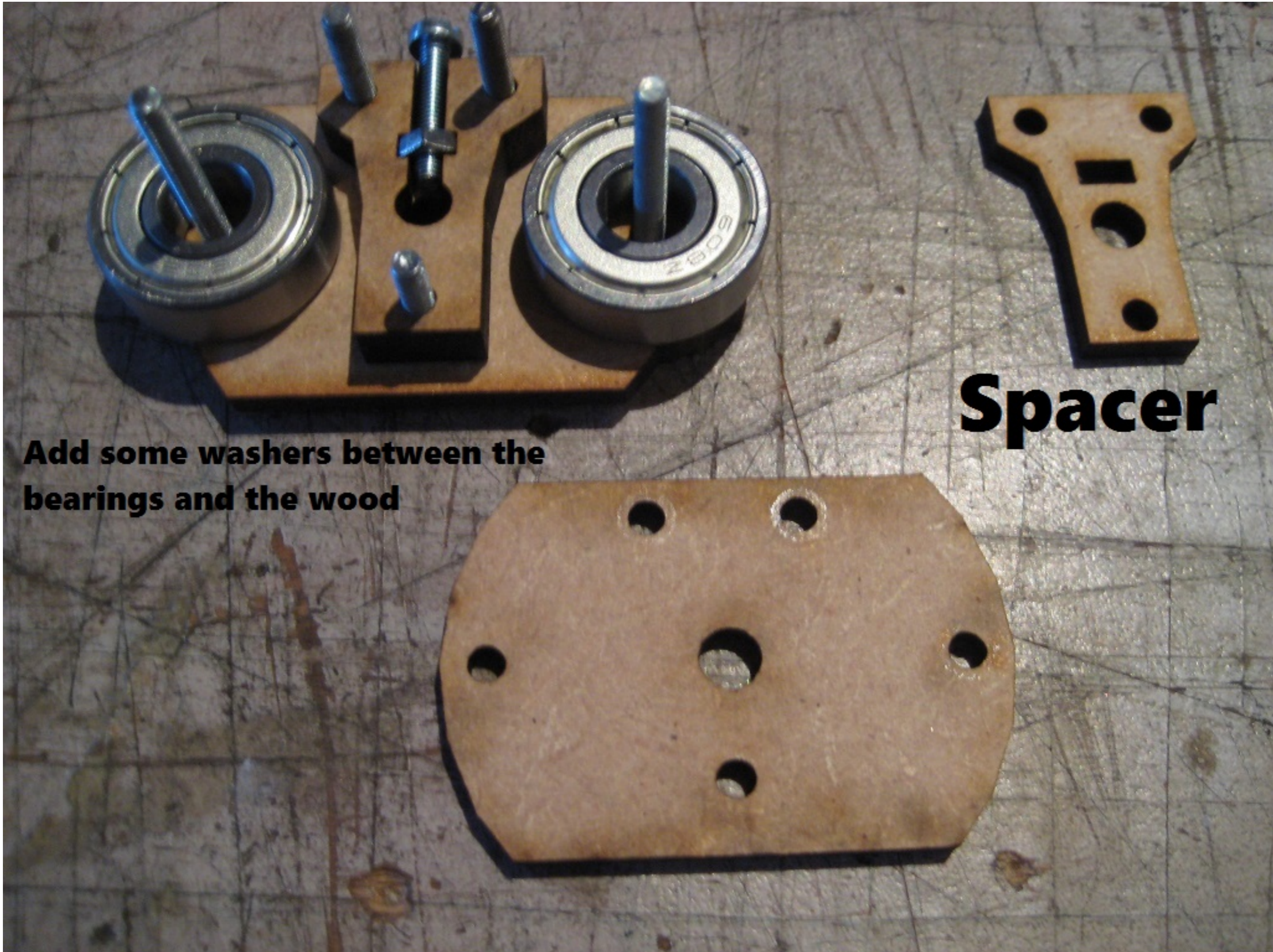

Add some washers between the bearings and the wood

Spacer



Control panel

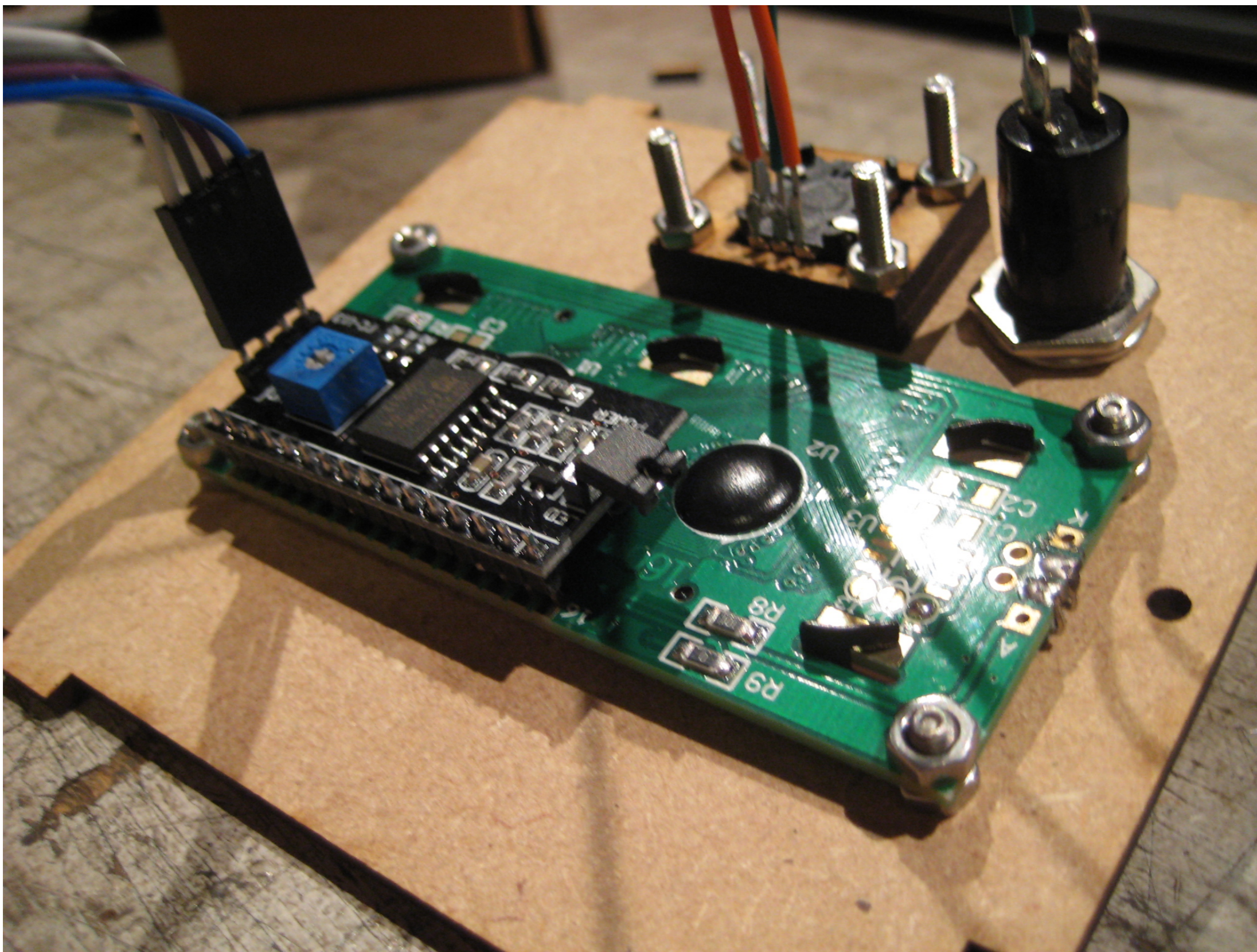



NEMA17 mount

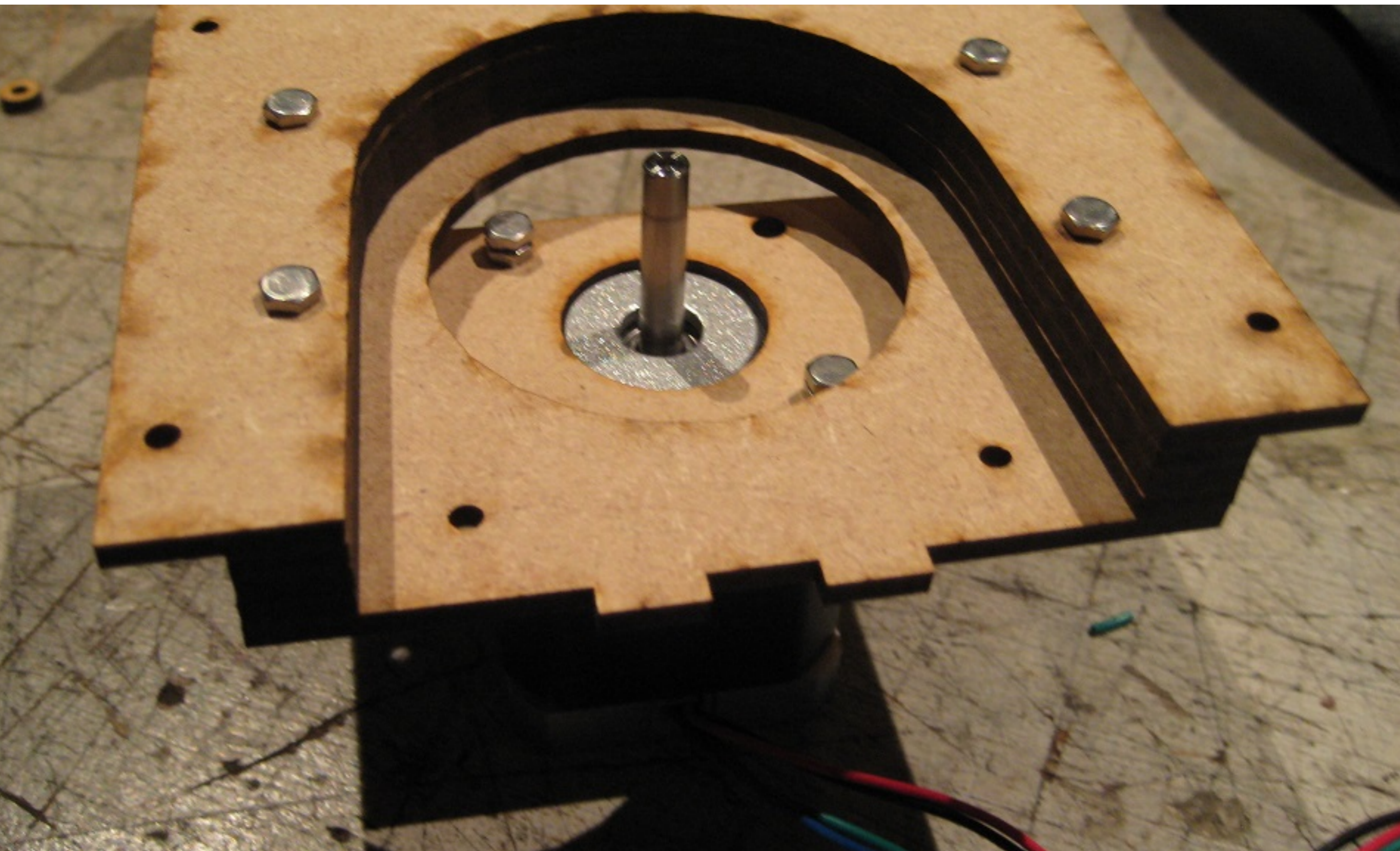



Component Wiring

Peristaltic Pump connection diagram

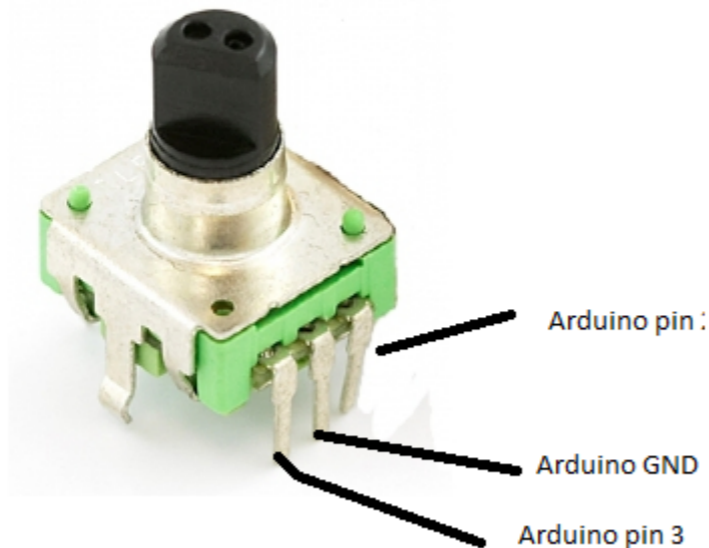
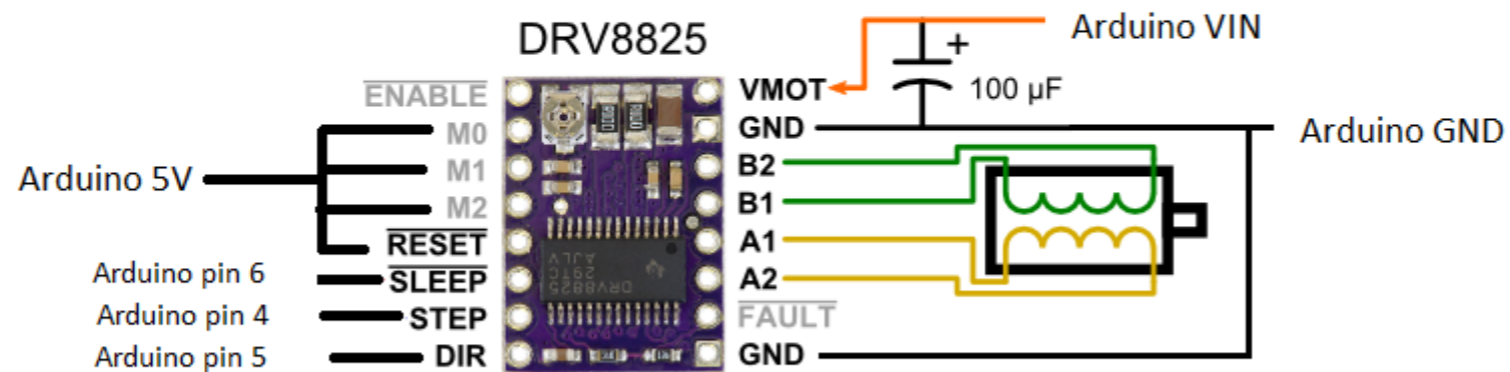



Stepper driver

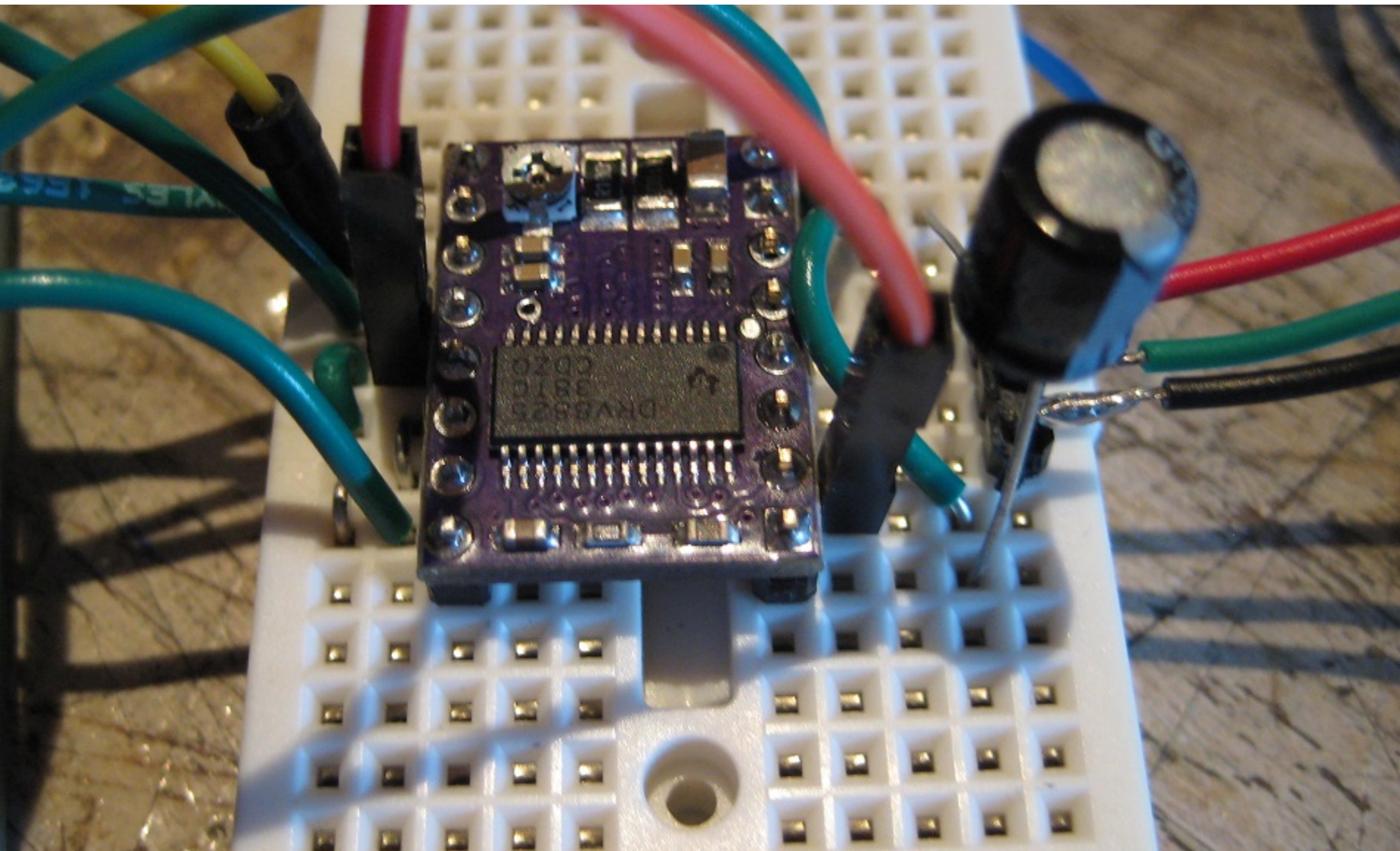



Full assembly

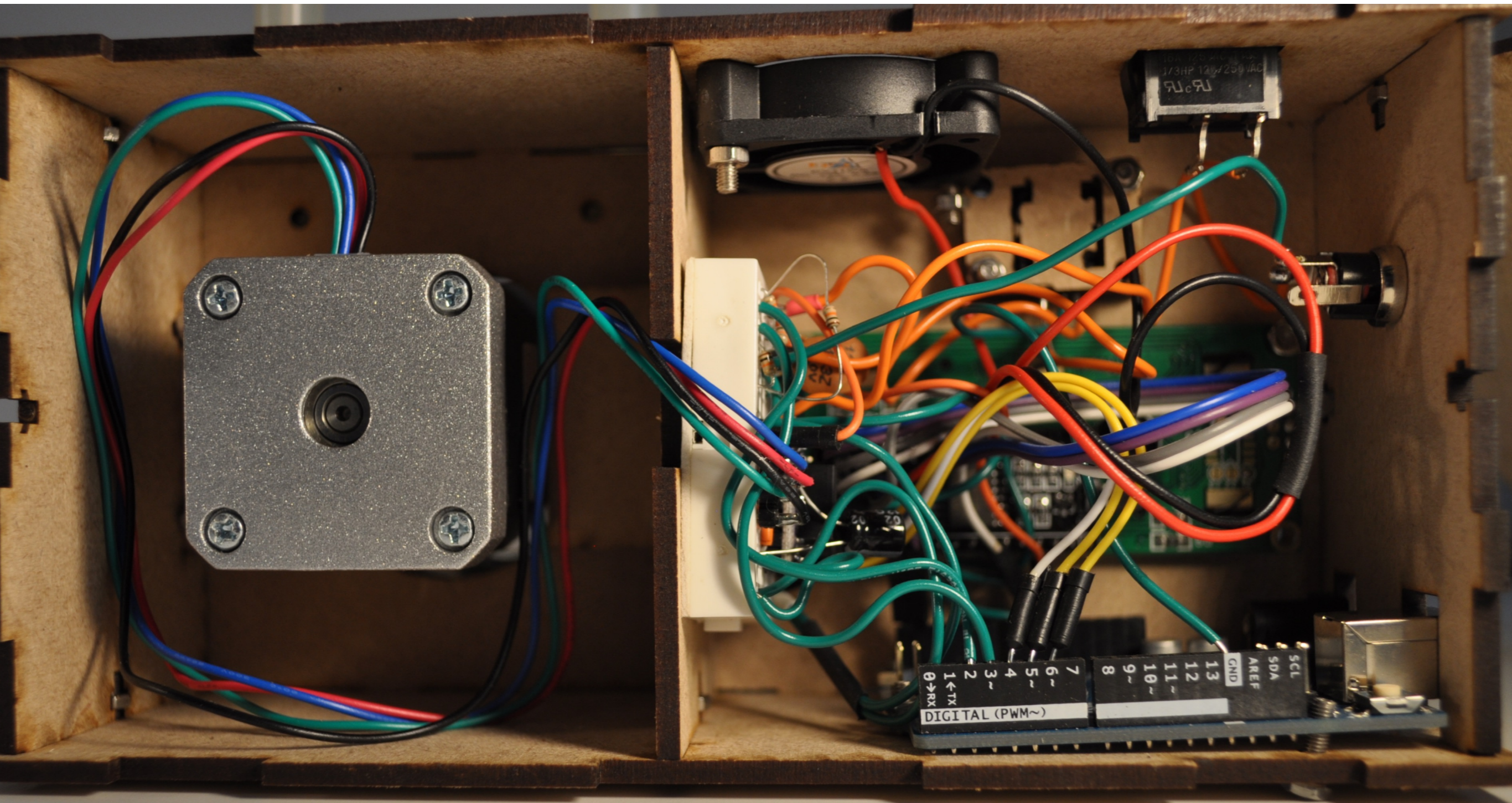



waag society

institute for art, science and technology

Demonstration

[http://www.youtube.com/watch?
v=rvNwhfQSCfg](http://www.youtube.com/watch?v=rvNwhfQSCfg)



**some
rights
reserved**